

Varenummer: 03446240
Beskrivelse: Fluro Heavy Duty Ledleje GE 240 GW-2RS
Hul Ø240
Note: 240

Mål

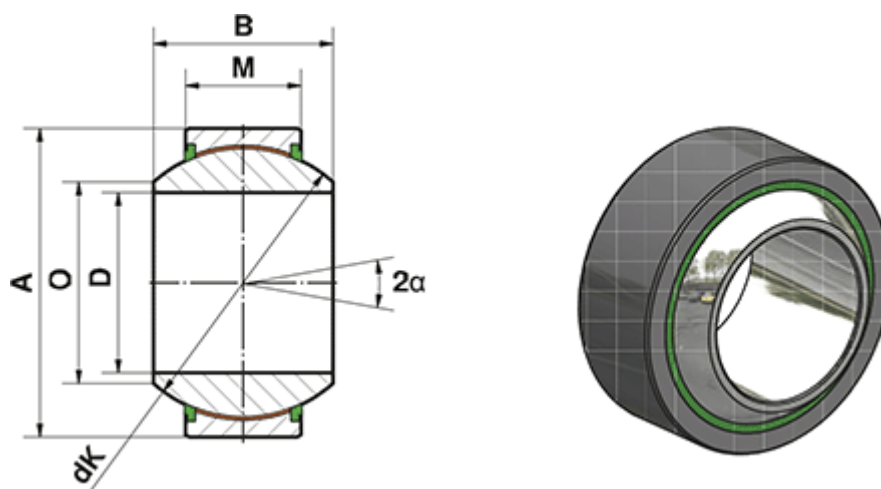

= -	Dynamisk belastning C (kN) = 8550
= -	M = 110
= -	O = 263.6
A = 370	Statisk belastning C0 (kN) = 14250
a (grader) = 15	Vægt (g) = 64000
B = 190	
D = 240	
dK = 325	